



CHINMORE INDUSTRY CO.,LTD

Specification

1. Product Type: 3G Rubber Stubby Antenna
2. *Chinmore's* No: EM-W247C-6ANT-059
3. Frequency: 800/900/1800/1900/2100 MHz
4. VSWR: 2.0:1
5. Impedance: 50 Ω
6. Connector: RA SMA M
7. Operating Temperature Range: -20°C ~ +60°C
8. Storage Temperature Range: -30°C ~ +70°C

※RoHS Compliant

※ISO 9001 & ISO14001

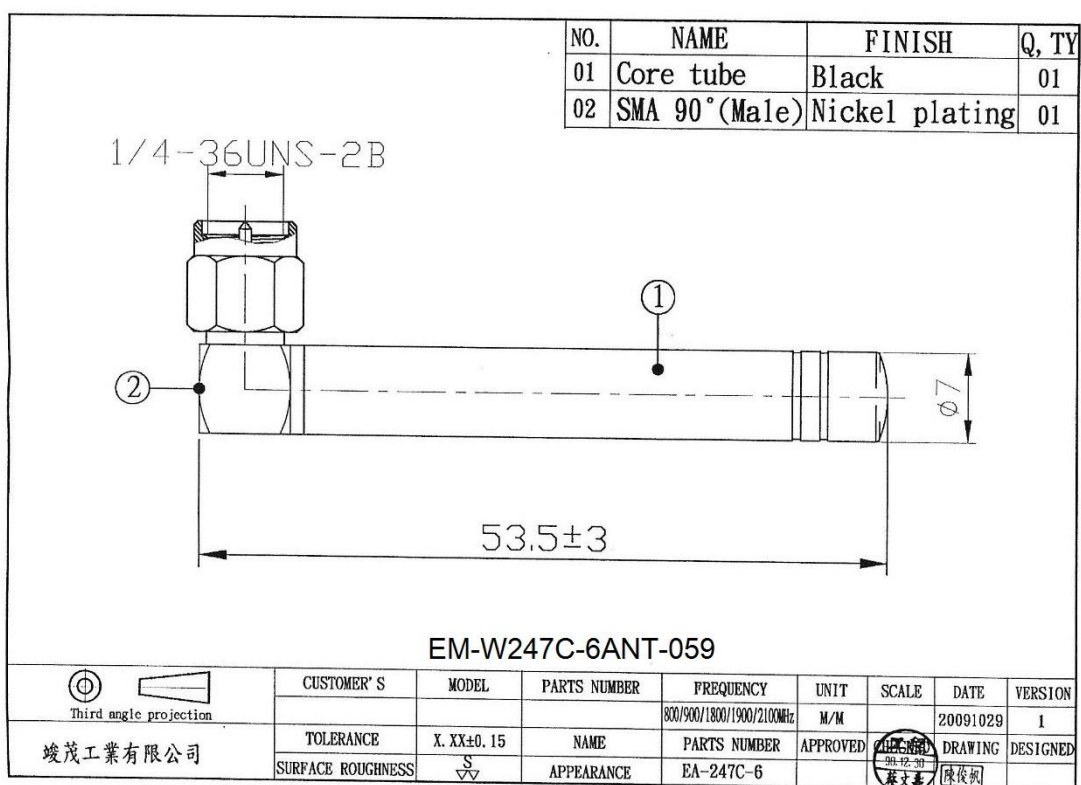

Frequency (MHz)	Return Loss (dB)	VSWR	Efficiency (%)	Gain (dBi)
824	-15.04	1.42	14.96	-5.31
960	-8.11	2.28	27.42	-2.84
1710	-5.15	3.44	52.6	1.16
2170	-15.48	1.41	26.36	-1.02

Test Data(Return Loss & VSWR)

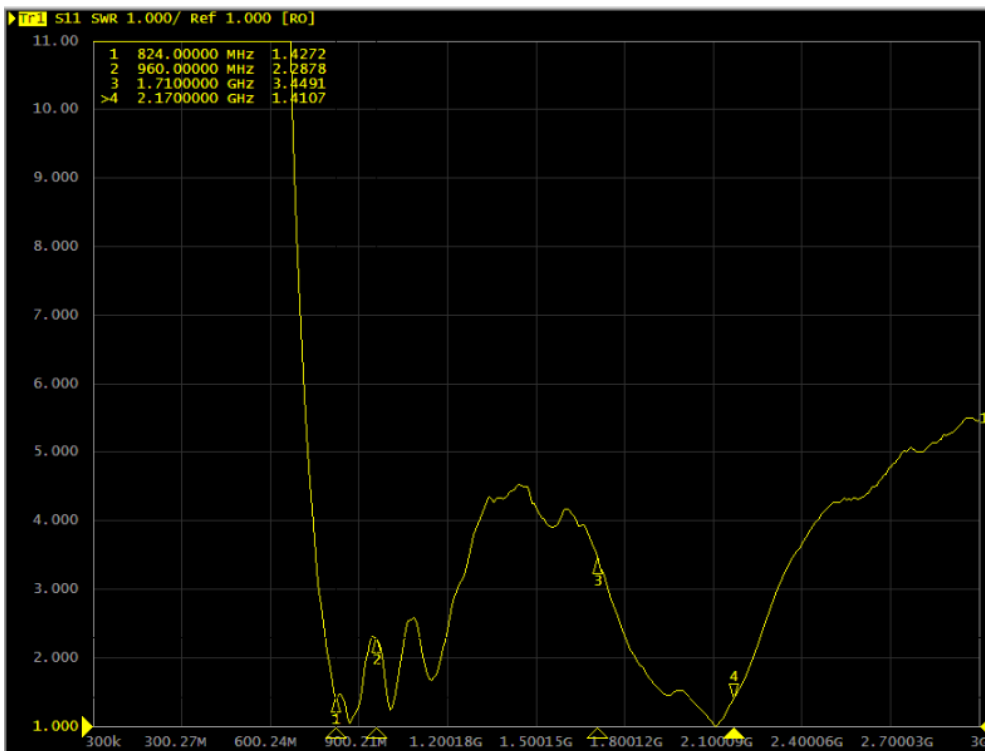
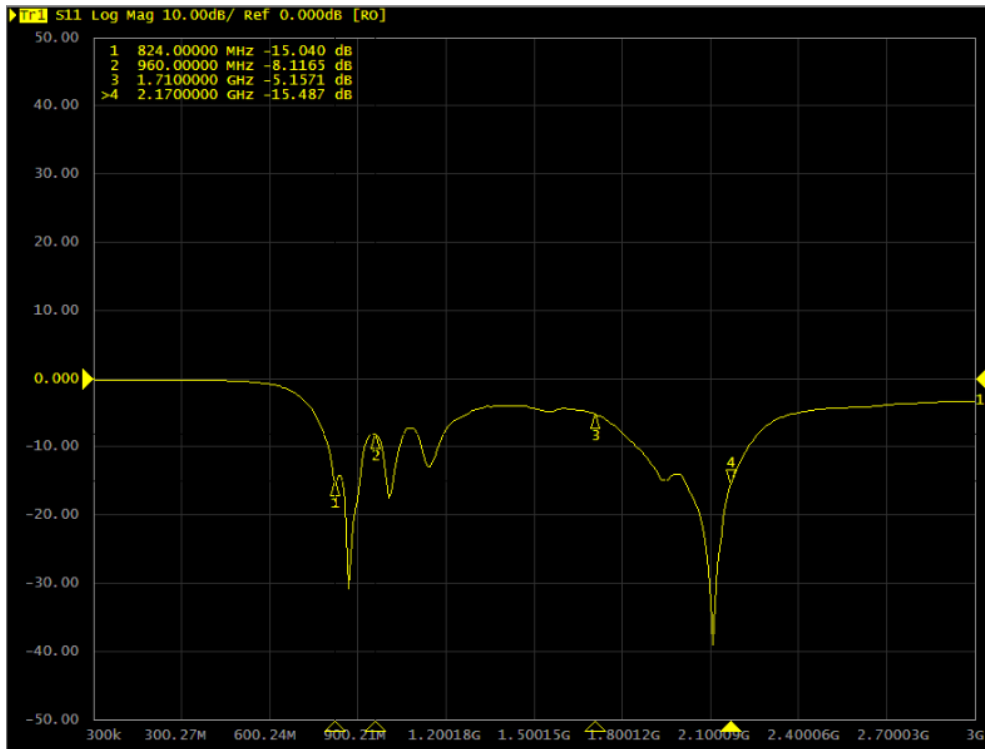

3D Test Photo

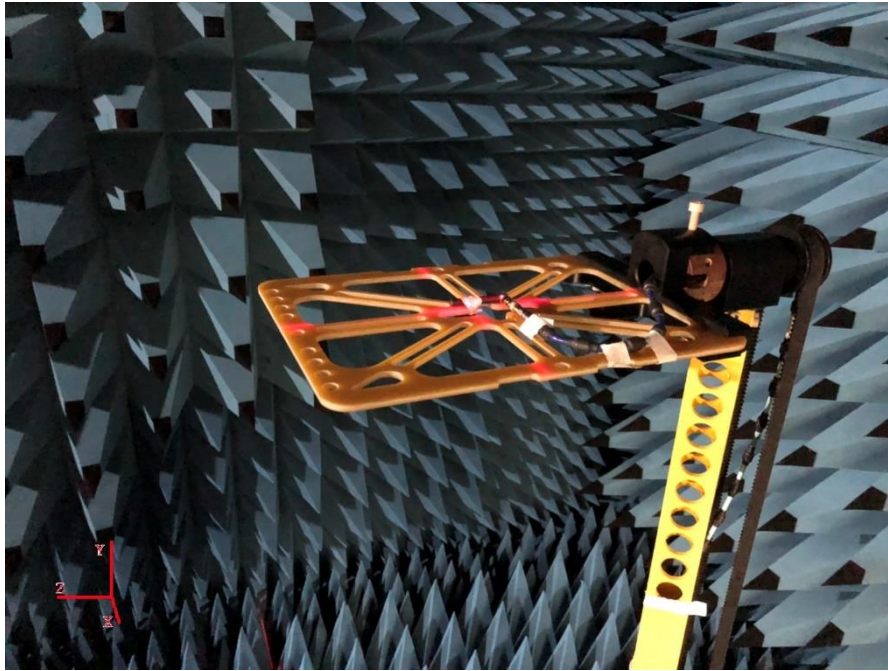

3D Test Data

Choose	Freq. / Chan.	Color
<input checked="" type="checkbox"/>	824MHz	Red
<input checked="" type="checkbox"/>	960MHz	Blue
<input checked="" type="checkbox"/>	1.71GHz	Green
<input checked="" type="checkbox"/>	2.17GHz	Magenta

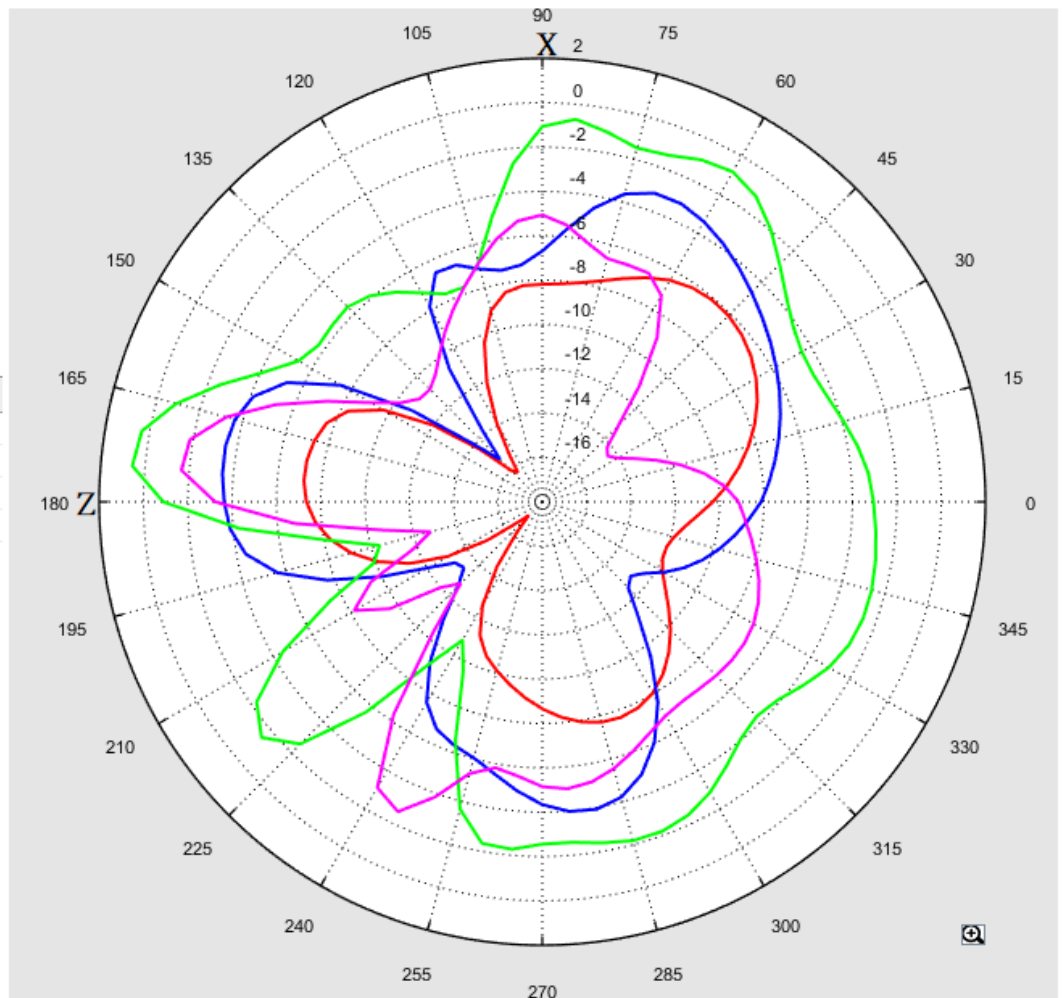

Total_Efficiency (%)

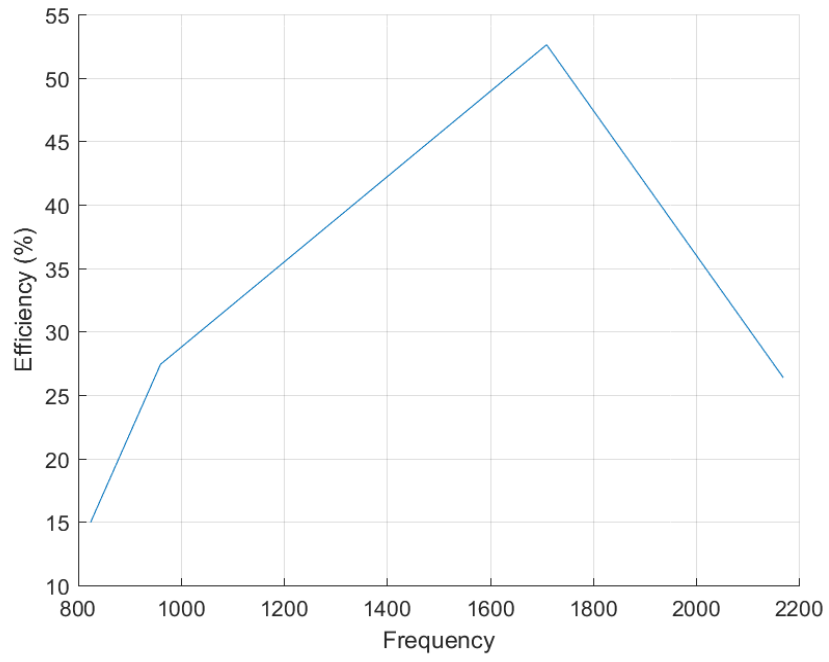

Total_Gain (dBi)

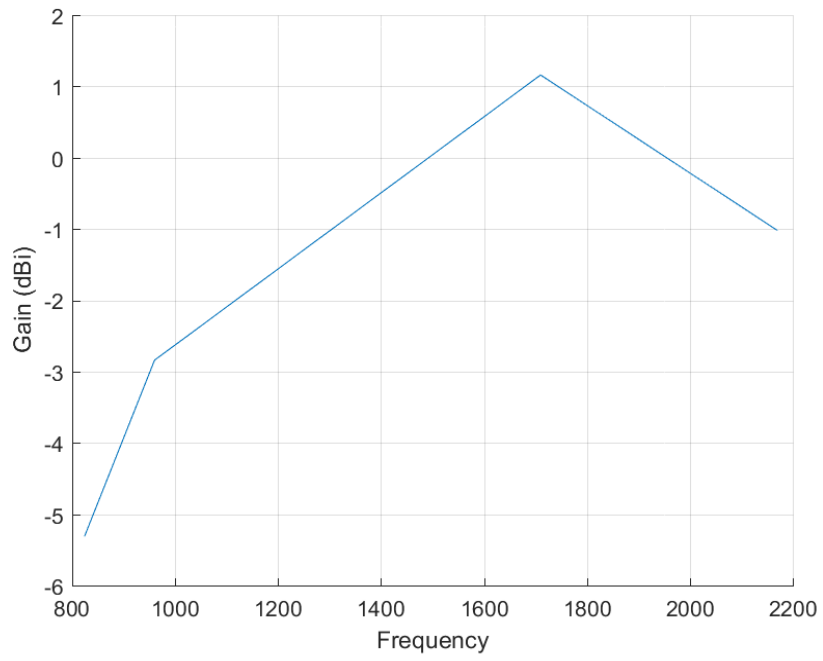

Total_3D_Top View_824MHz

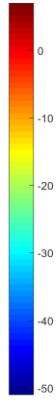
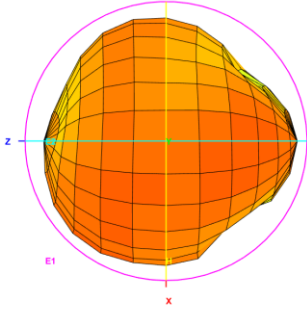

Total_3D_Front View_824MHz

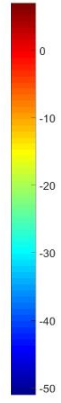
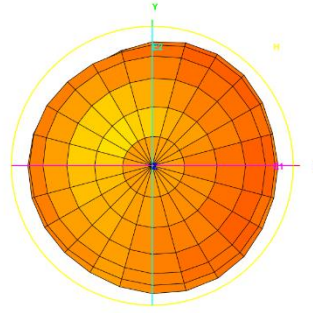

Total_3D_Left View_824MHz

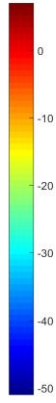
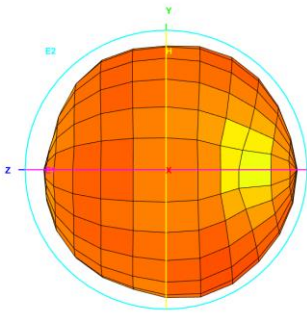

Total_3D_Side View 1_824MHz

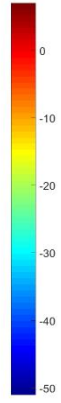
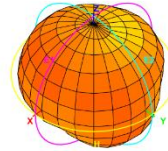

Total_3D_Top View_960MHz

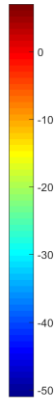
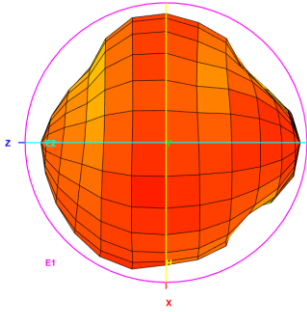

Total_3D_Front View_960MHz

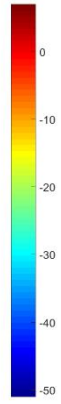
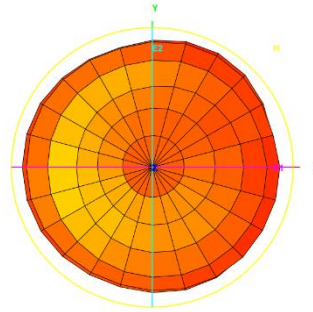

Total_3D_Left View_960MHz

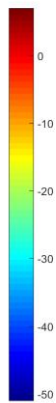
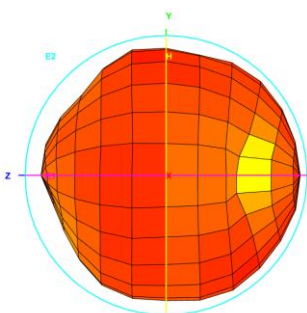

Total_3D_Side View 1_960MHz

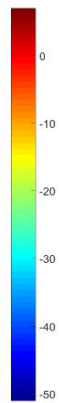
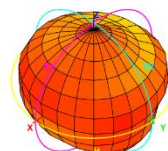

Total_3D_Top View_1.71GHz

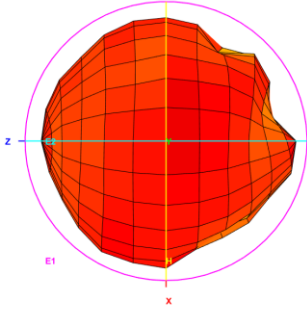

Total_3D_Front View_1.71GHz

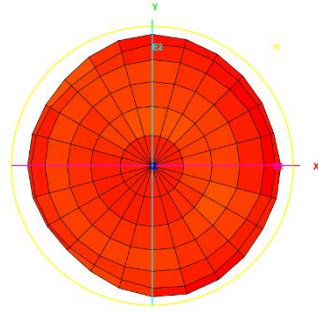

Total_3D_Left View_1.71GHz

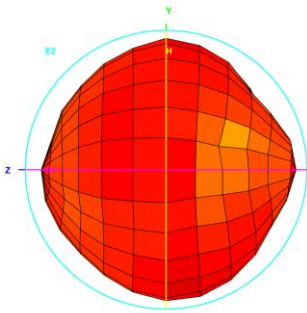

Total_3D_Side View 1_1.71GHz

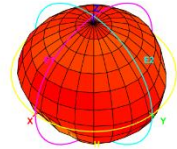

Total_3D_Top View_2.17GHz

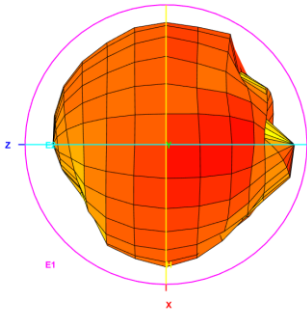

Total_3D_Front View_2.17GHz

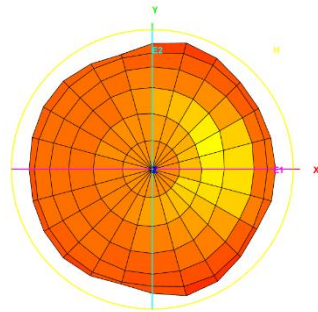

Total_3D_Left View_2.17GHz

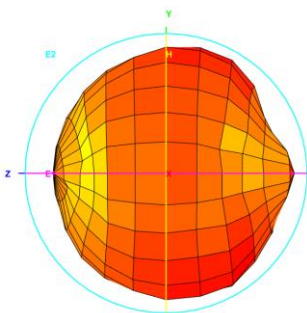

Total_3D_Side View 1_2.17GHz

