



CHINMORE INDUSTRY CO.,LTD

Specification

1. Adhesive Mount Antenna for 3G/GSM
2. *Chinmore's* No: CA-C09-1FMFEF-019
3. Frequency: 900~1800 MHz
4. VSWR: 2.0:1
5. Gain: 2.5dBi
6. Impedence: 50Ω
7. Cable: RG-174 3M
8. Connector: FME F

✧RoHS Compliant

✧ISO 9001 & ISO 14001

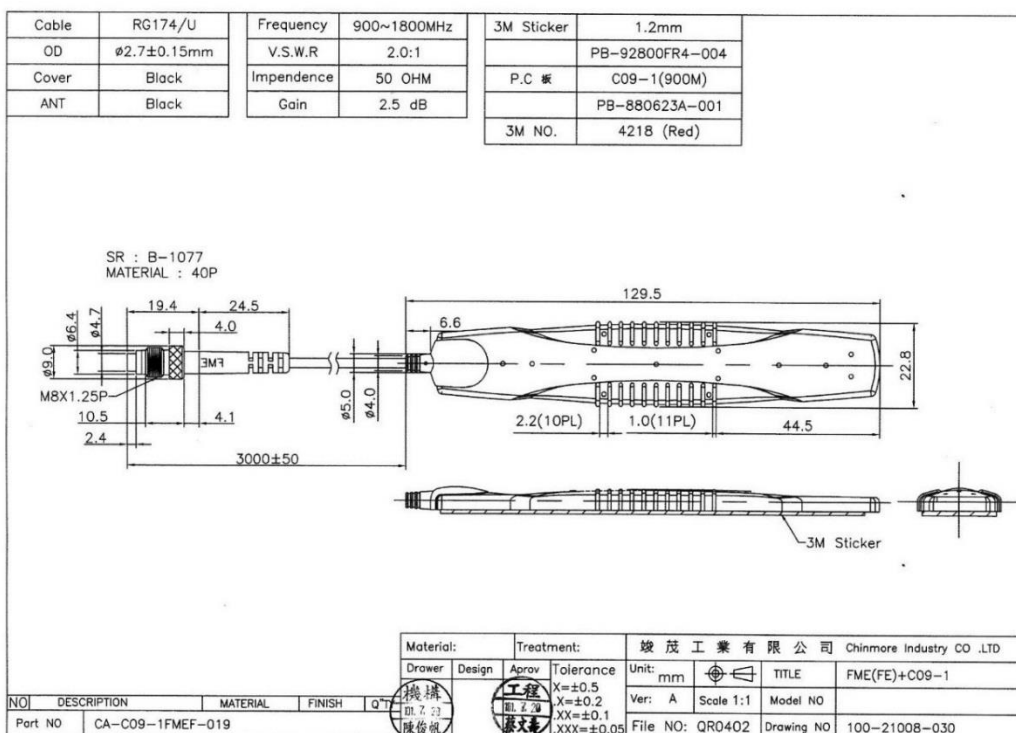

Frequency (MHz)	Return Loss (dB)	VSWR	Efficiency (%)	GAIN (dB)
900	-16.01	1.36	41.69	1.78
1800	-14.62	1.45	81.28	4.77

Test Data

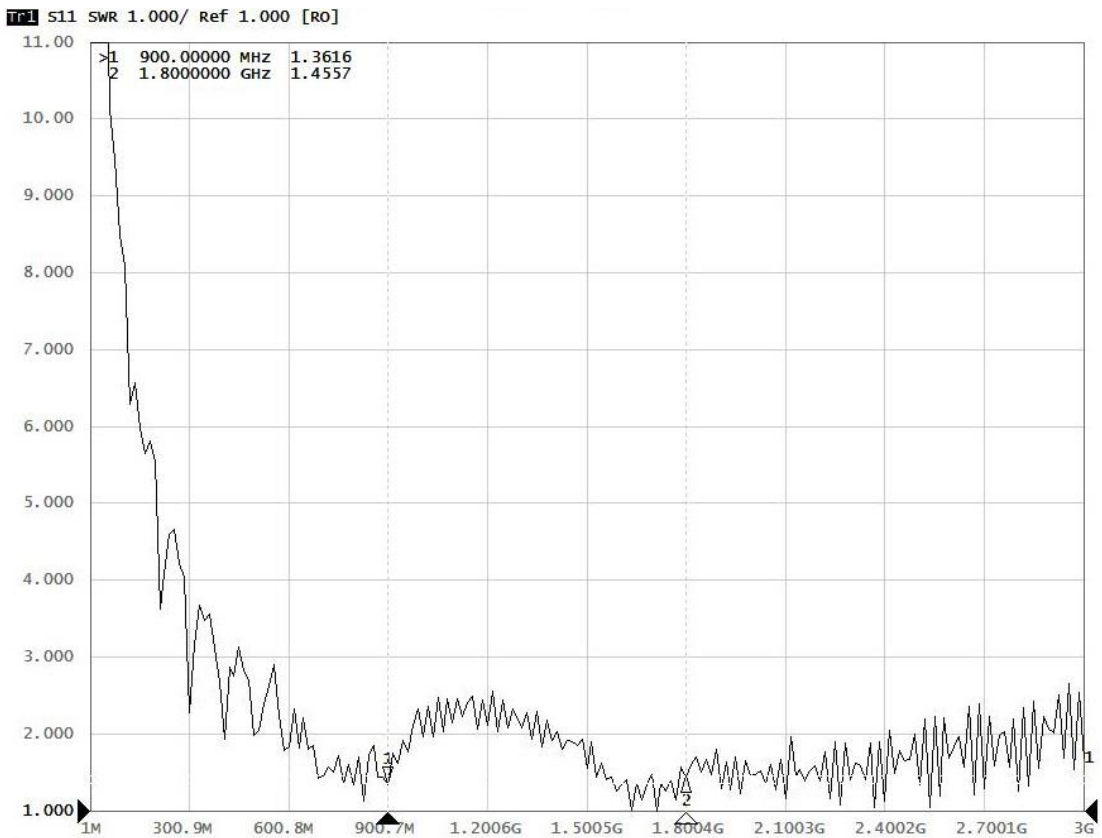
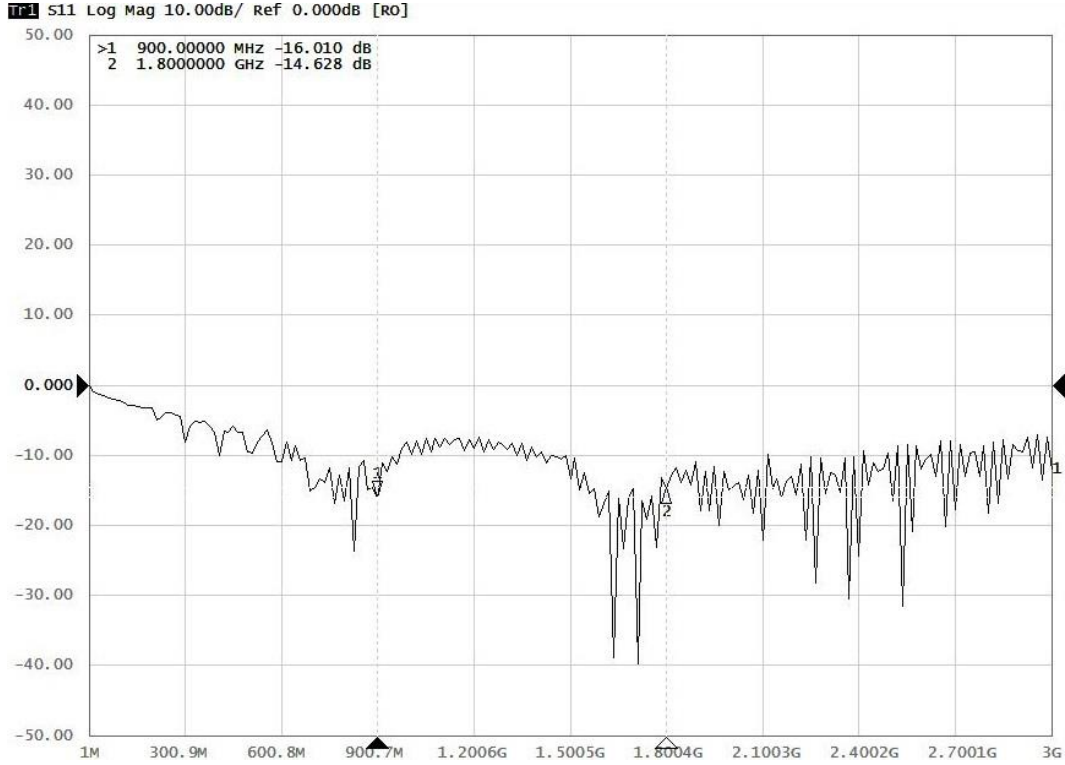

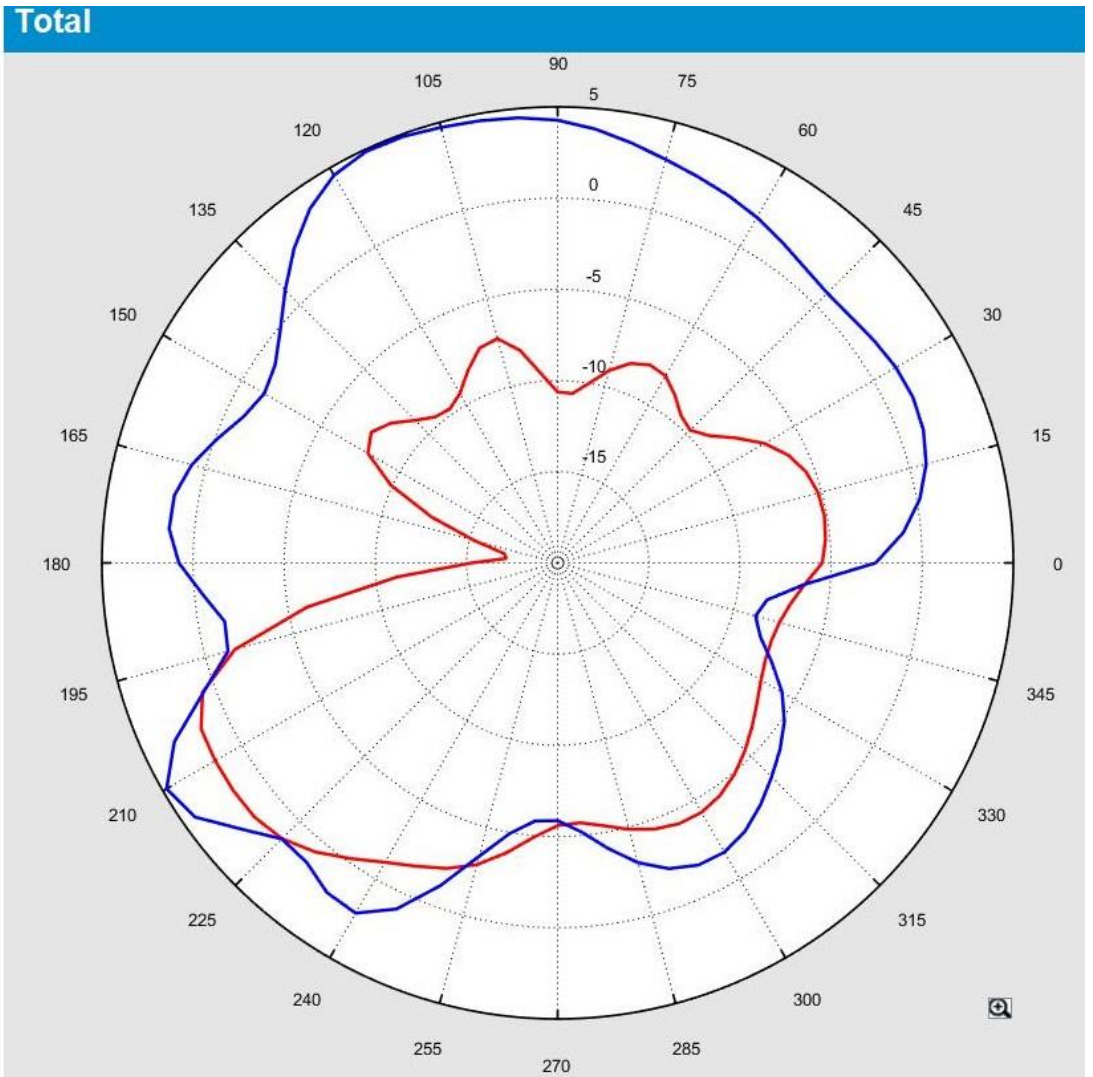

Total_Efficiency (%)

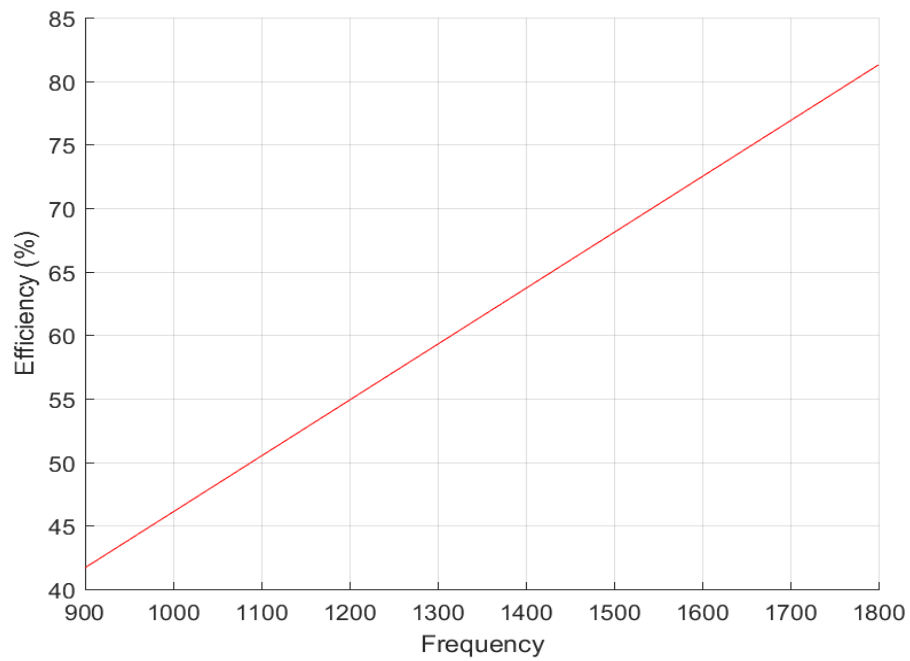

Total_Gain (dBi)

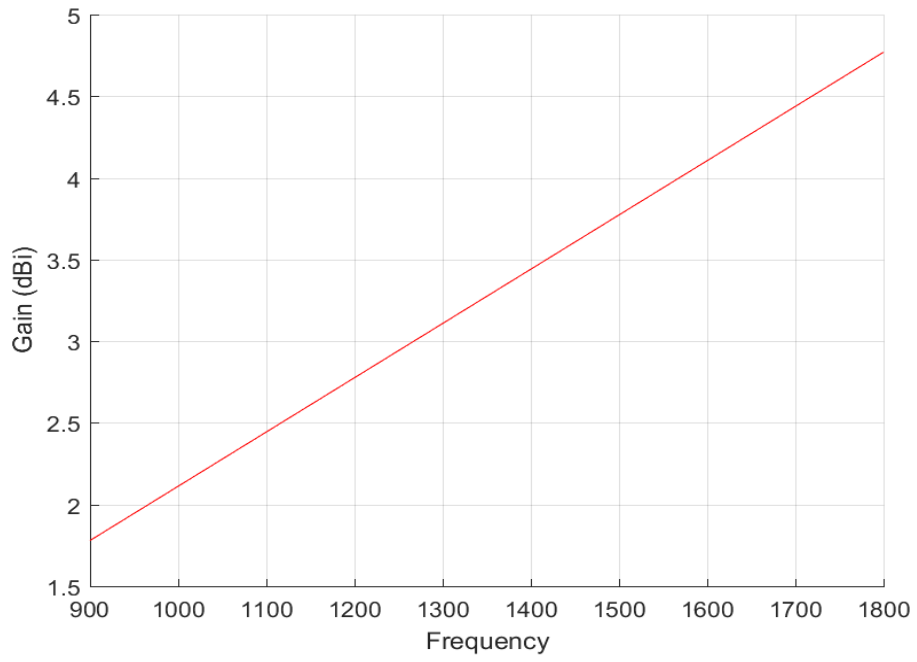

Total_3D_Side View 1_900MHz

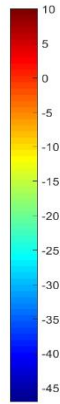
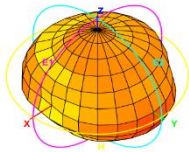

Total_3D_Side View 1_1.8GHz

