



CHINMORE INDUSTRY CO.,LTD

Specification

1. Rubber Stubby Antenna for 869MHz
2. *Chinmore's* No: EM-B8.0X74.0-156
3. Frequency: 869 MHz
4. VSWR: 2.0:1
5. Impedance: 50 Ω
6. Connector: SMA (M)
7. Color: Black

※RoHS Compliant

※ISO 9001 & ISO 14001

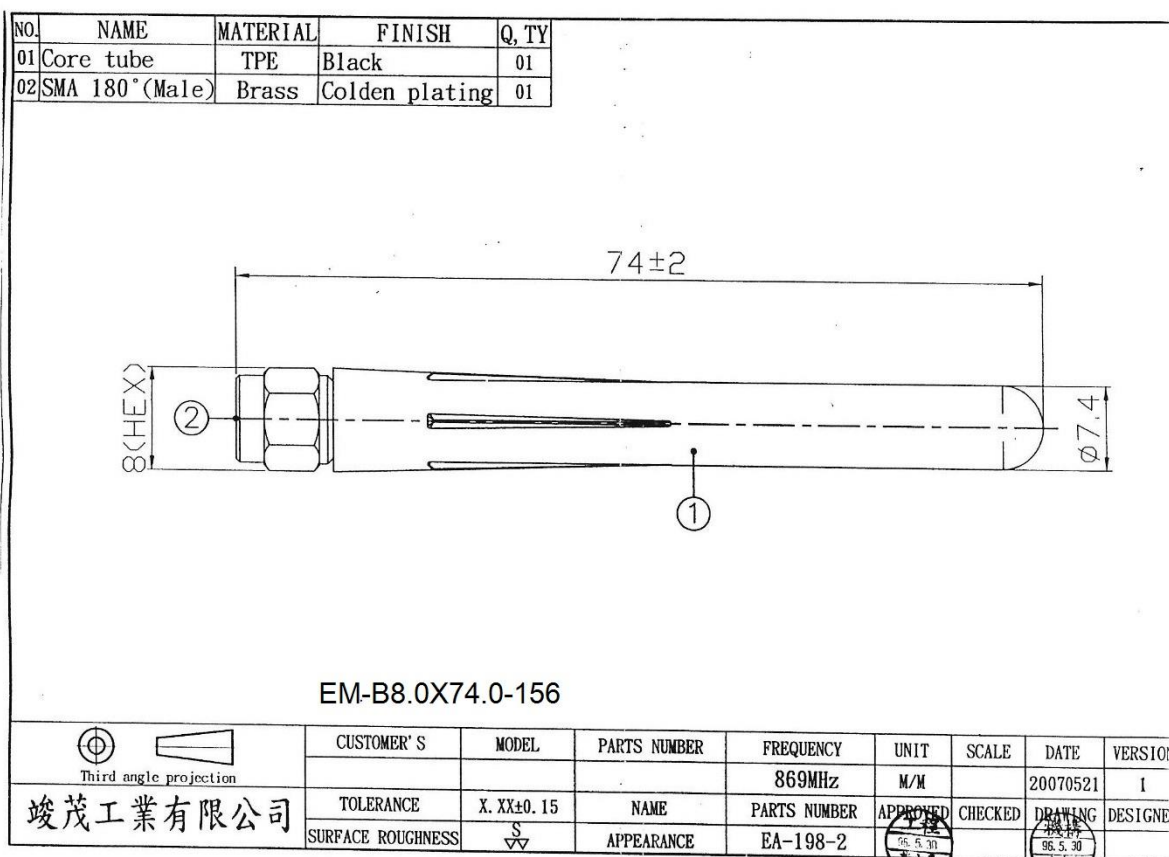

Frequency (MHz)	Return Loss (dB)	VSWR	Efficiency (%)	Gain (dBi)
859	-30.25	1.06	17.99	-4.31
869	-21.72	1.17	19.28	-3.95
879	-14.88	1.44	18.97	-3.91

Test Data(Return Loss & VSWR)

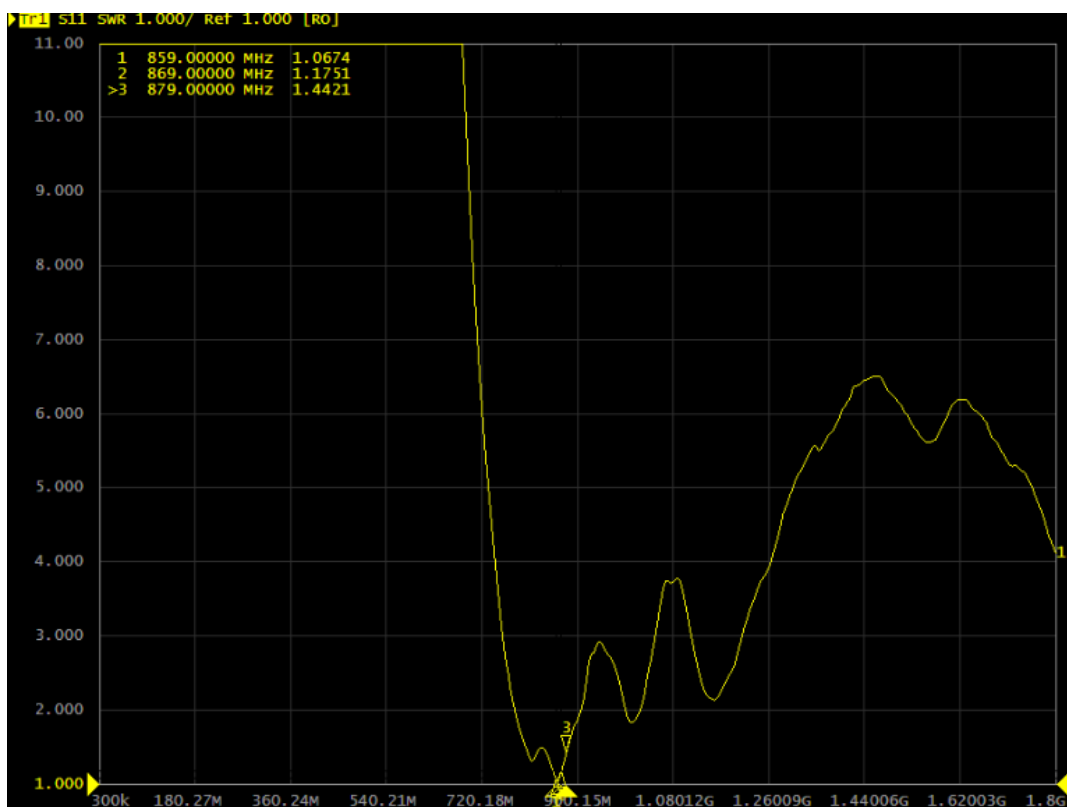
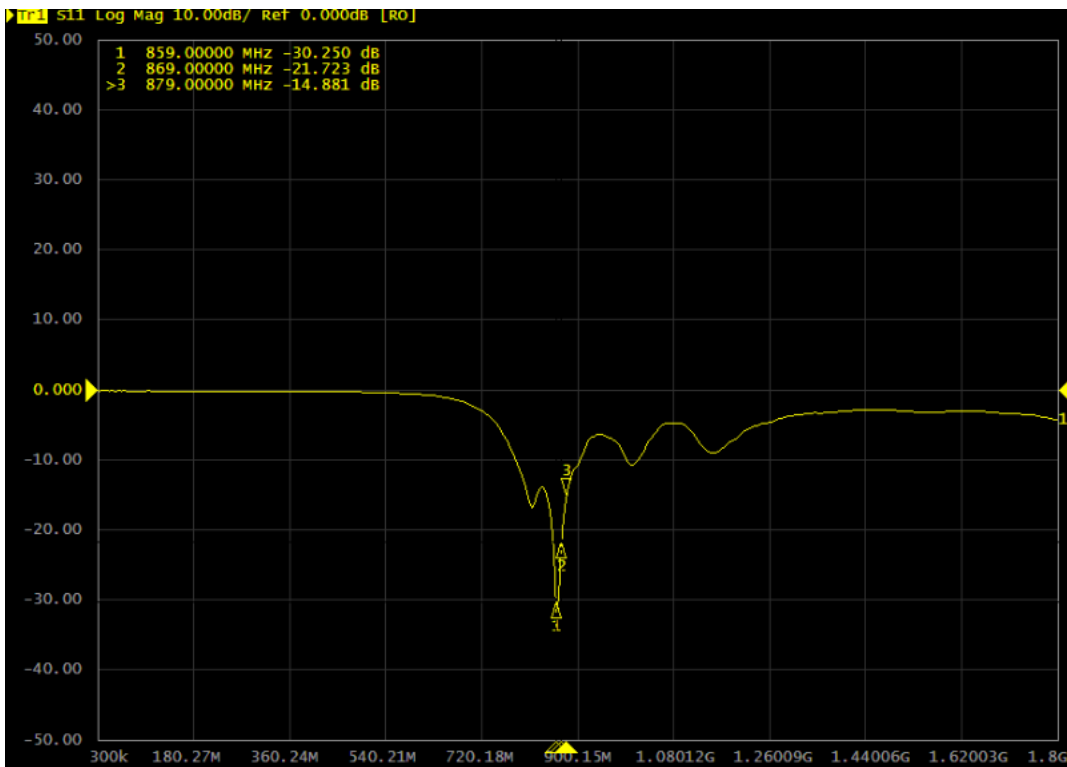

3D Test Photo

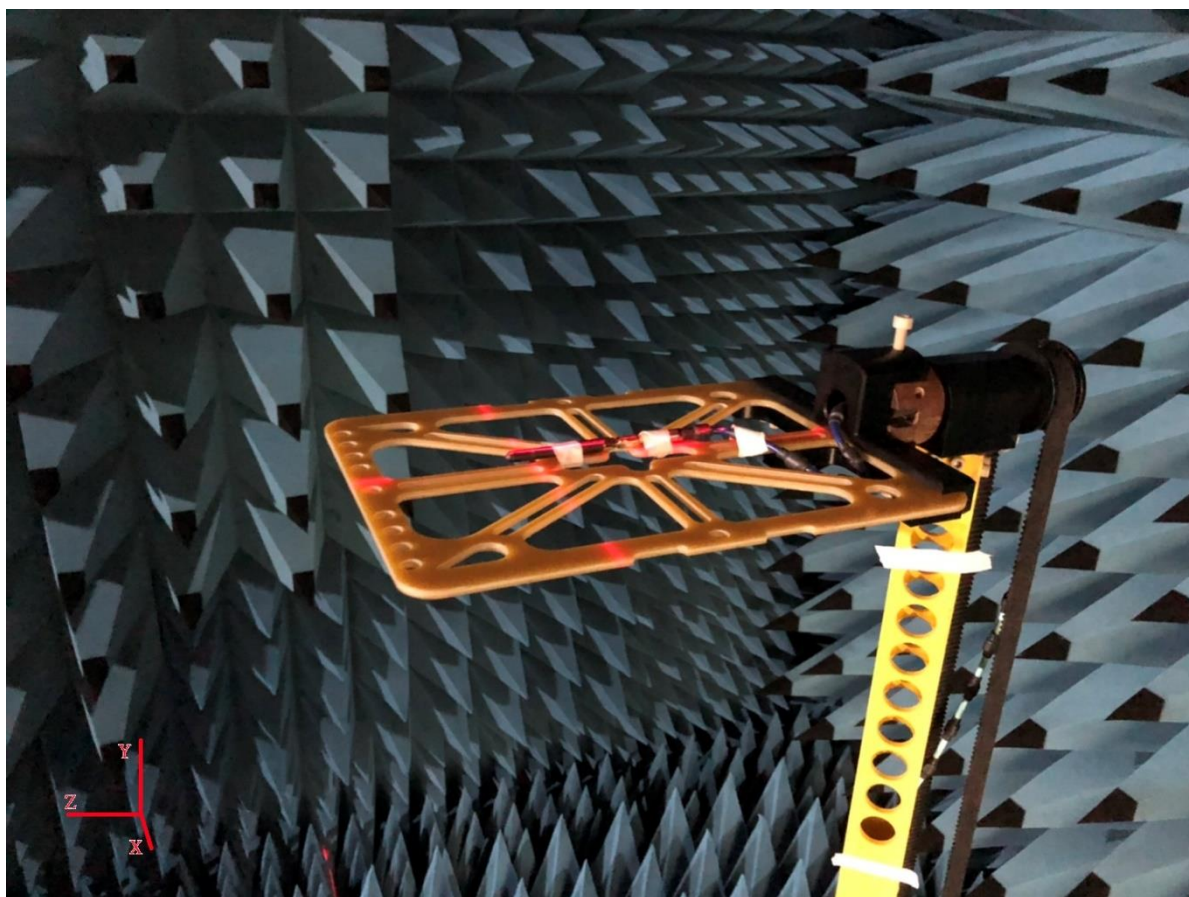

3D Test Data

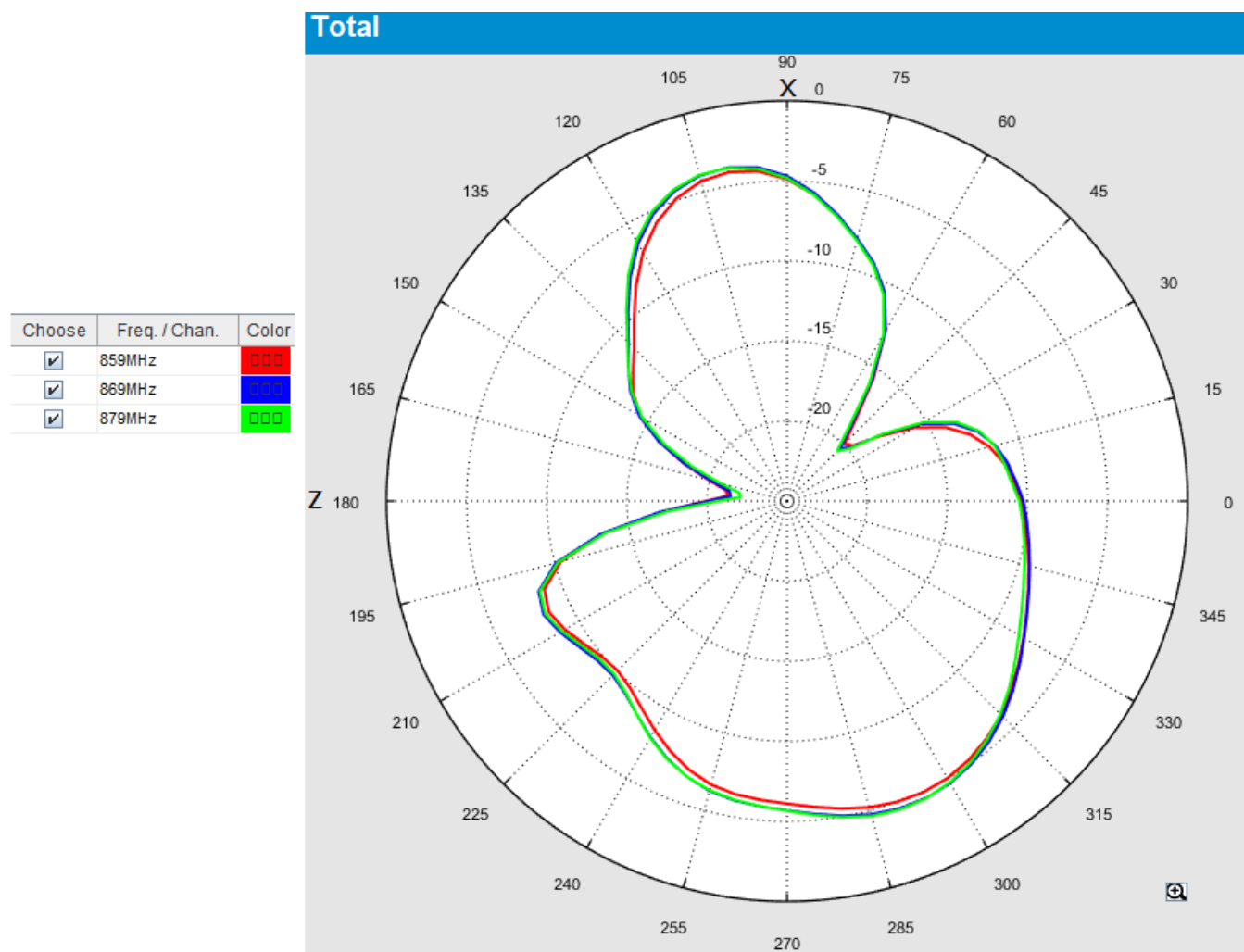

Total_Efficiency (%)

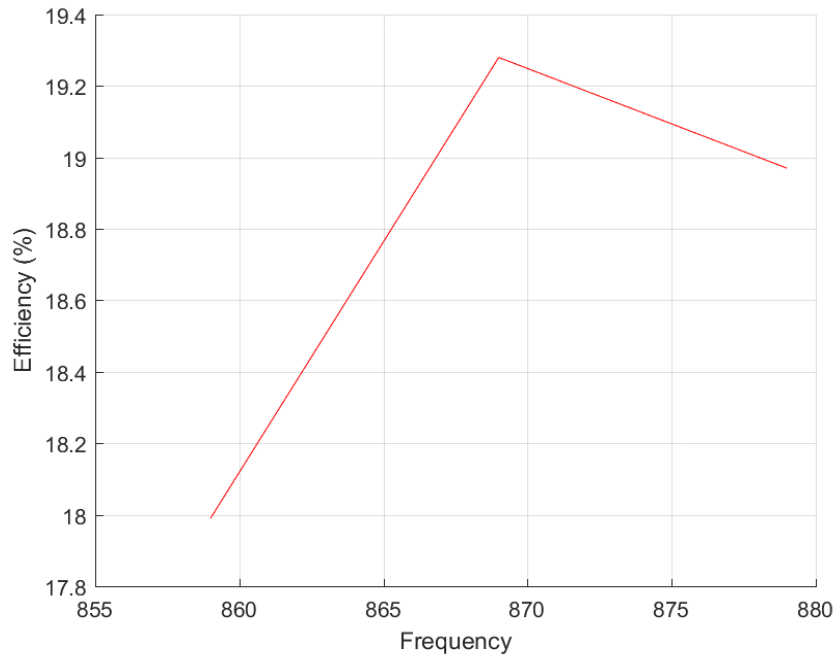

Total_Gain (dBi)

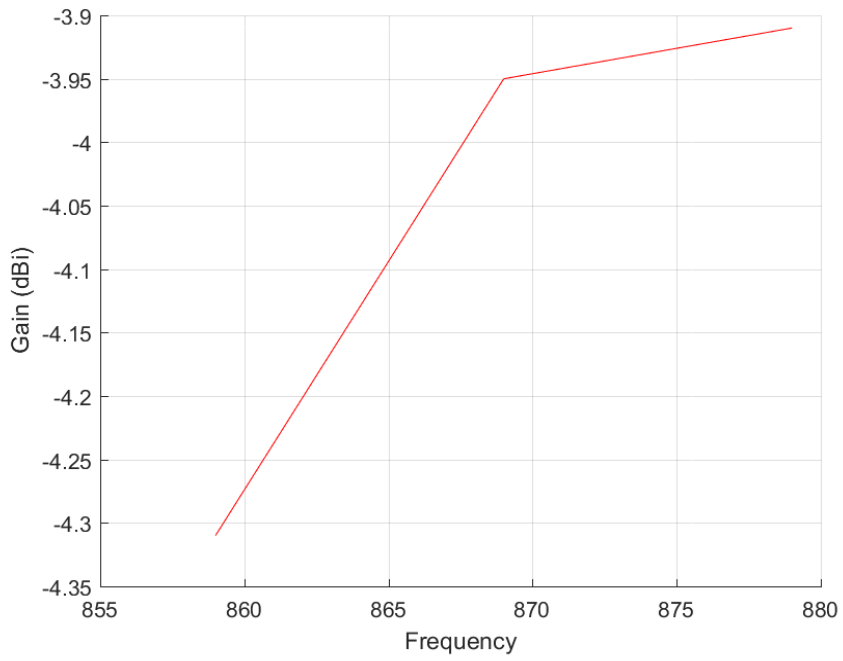

Total_3D_Top View_859MHz

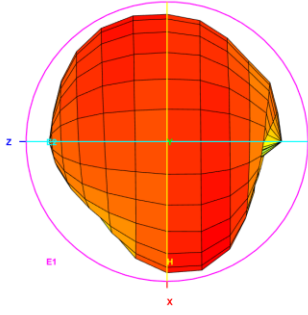

Total_3D_Front View_859MHz

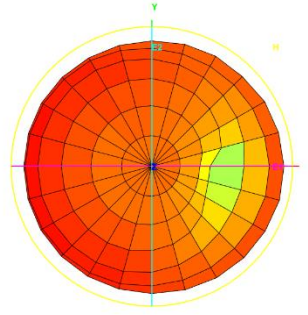

Total_3D_Left View_859MHz

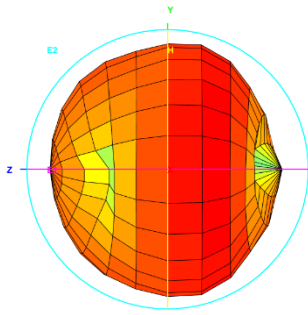

Total_3D_Side View 1_859MHz

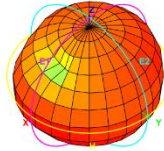

Total_3D_Top View_869MHz

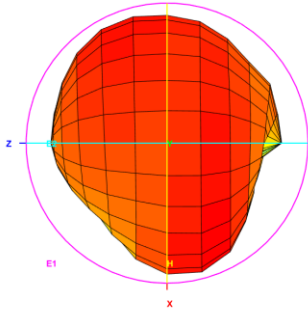

Total_3D_Front View_869MHz

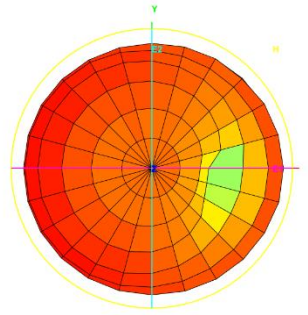

Total_3D_Left View_869MHz

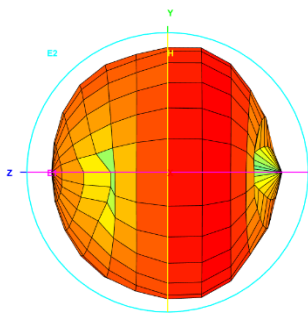

Total_3D_Side View 1_869MHz

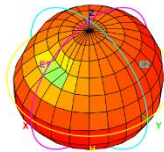

Total_3D_Top View_879MHz

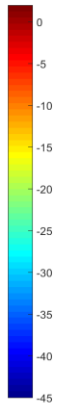
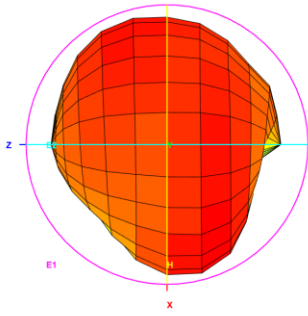

Total_3D_Front View_879MHz

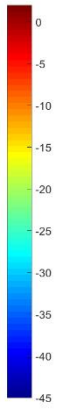
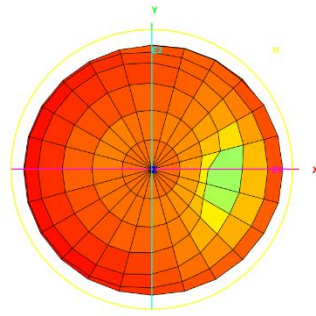

Total_3D_Left View_879MHz

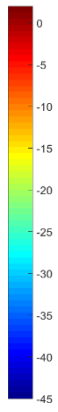
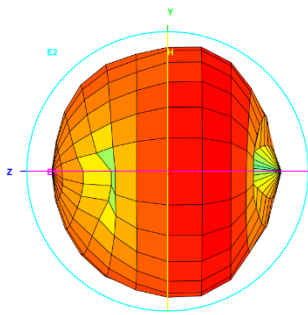

Total_3D_Side View 1_879MHz

