



CHINMORE INDUSTRY CO., LTD

Specification

1. 3G/GSM Rubber Stubby Antenna
2. *Chinmore's* No: EM-W261AAANT-080
3. Frequency: 824~960 MHz /1710~1990 MHz
4. Connector: FME F
5. VSWR: 2.0:1
6. Operating Temperature Range: -20°C~+60°C
7. Storage Temperature Range: -30°C~+70°C

※RoHS Compliant

※ISO 9001 & ISO 14001

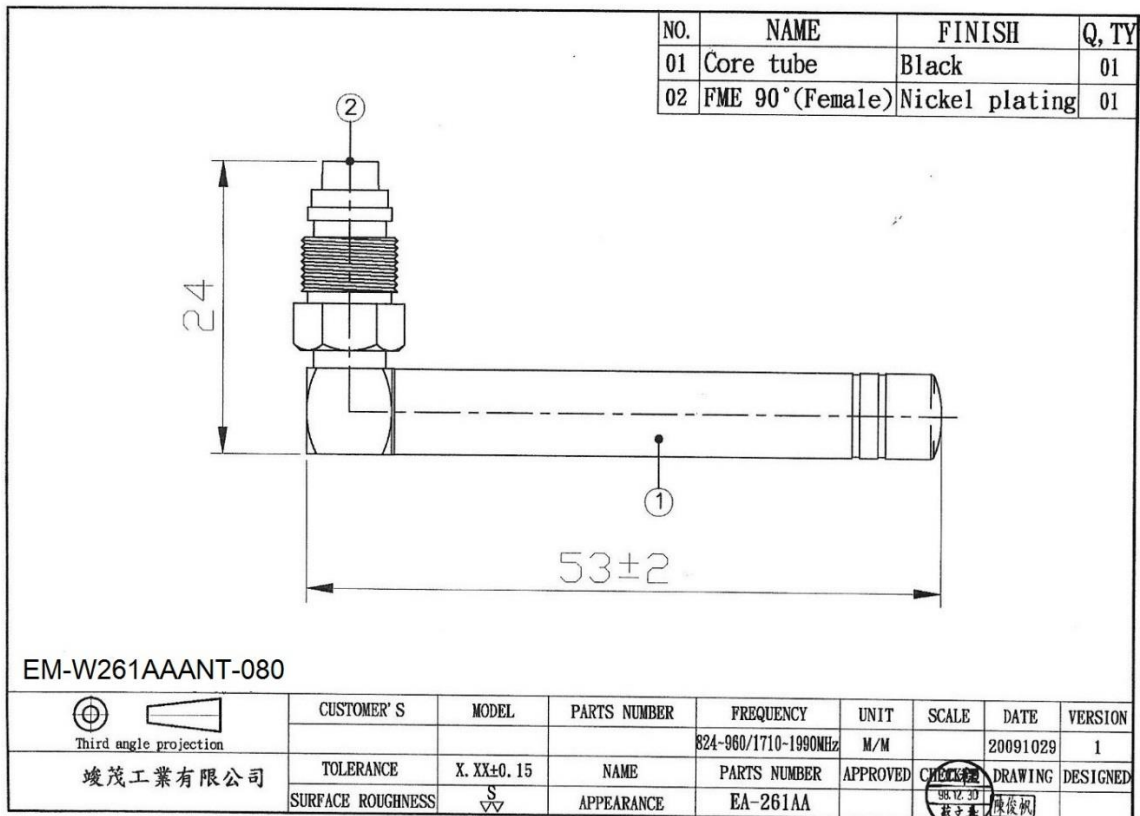

Frequency (MHz)	Return Loss (dB)	VSWR	Efficiency (%)	Gain (dBi)
824	-19.61	1.24	18.84	-4.66
960	-5.77	3.01	23.6	-3.18
1710	-5.30	3.46	44.16	0.5
1990	-9.50	2.06	39.9	0.32

Test Data(Return Loss & VSWR)

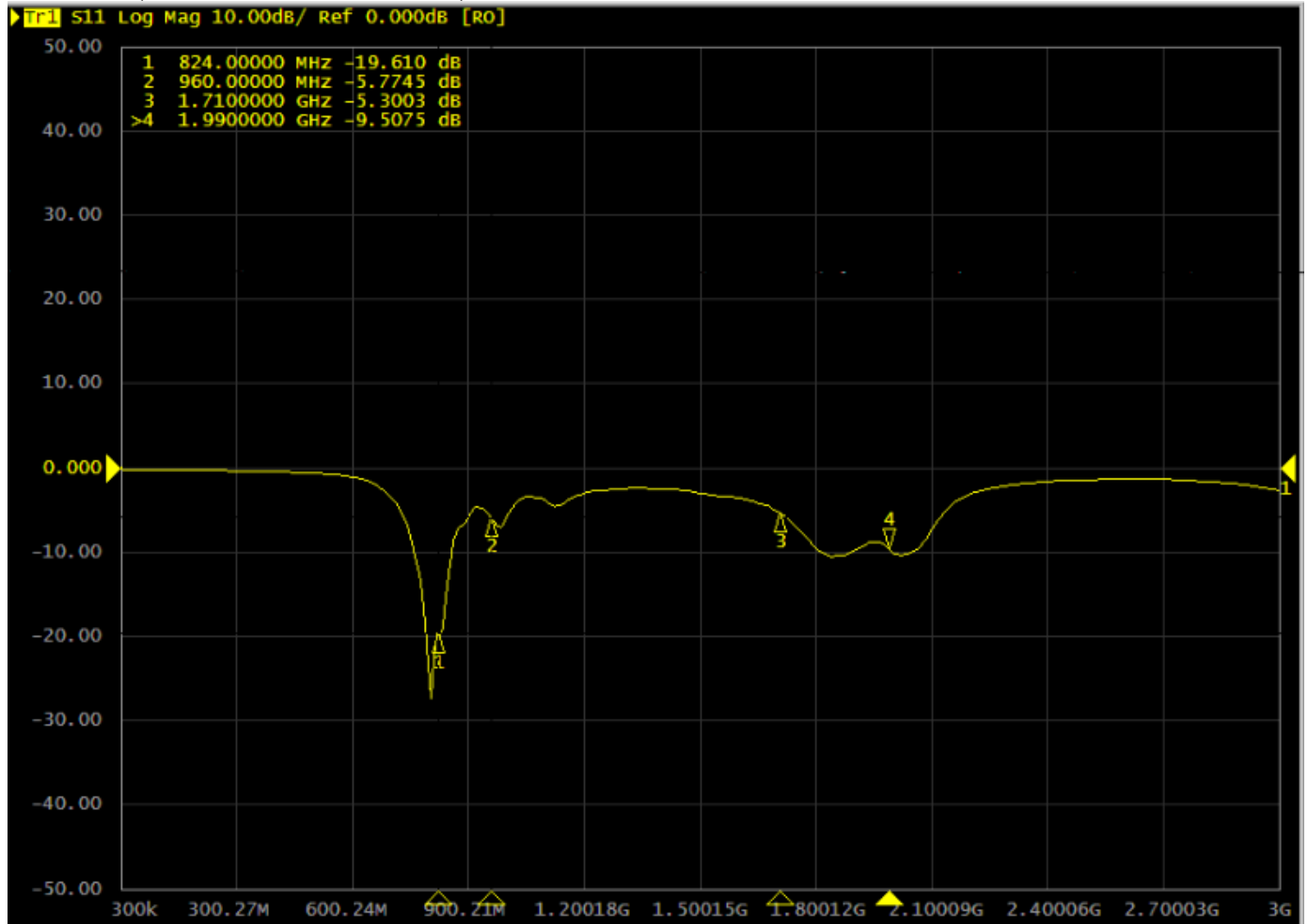

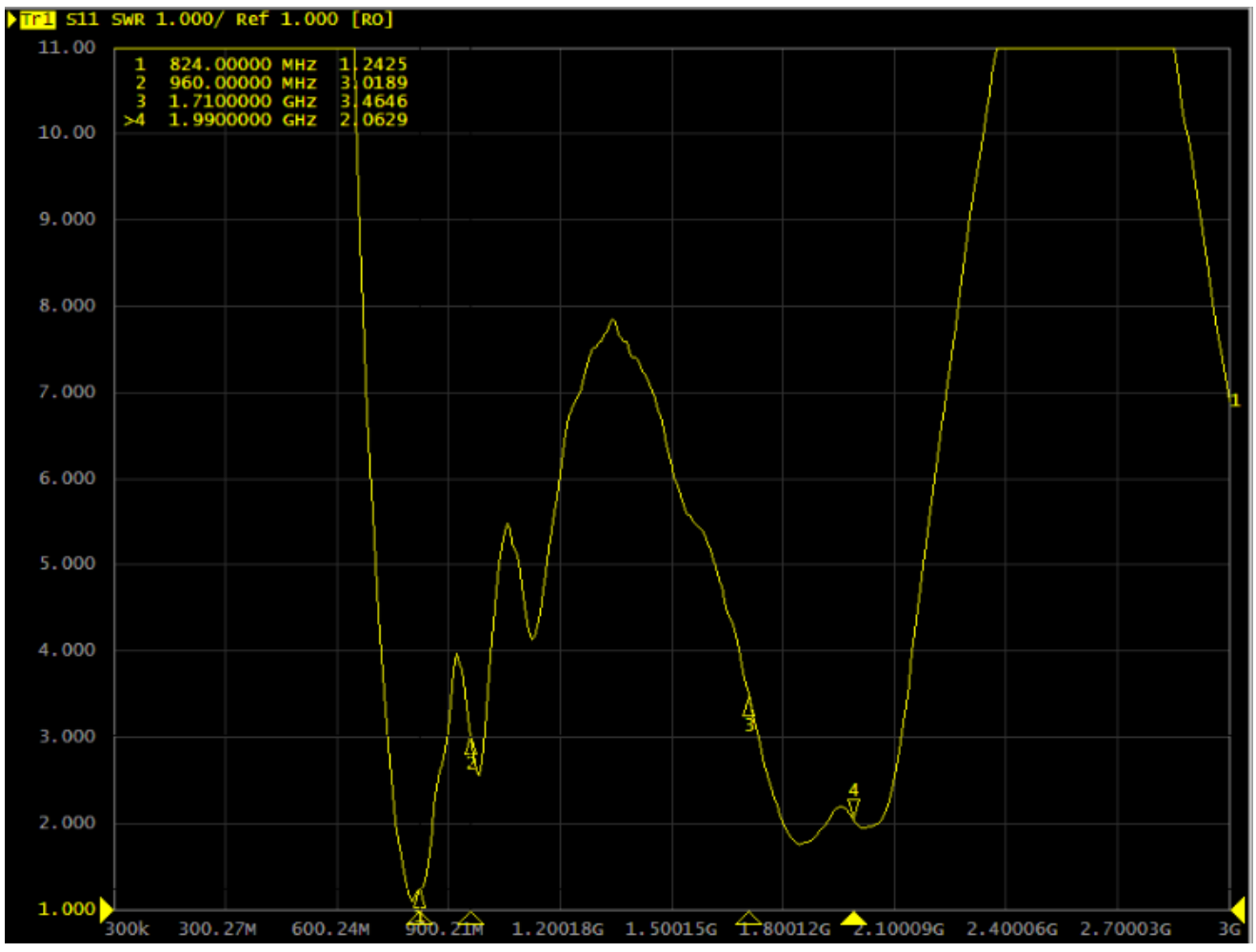

3D Test Photo

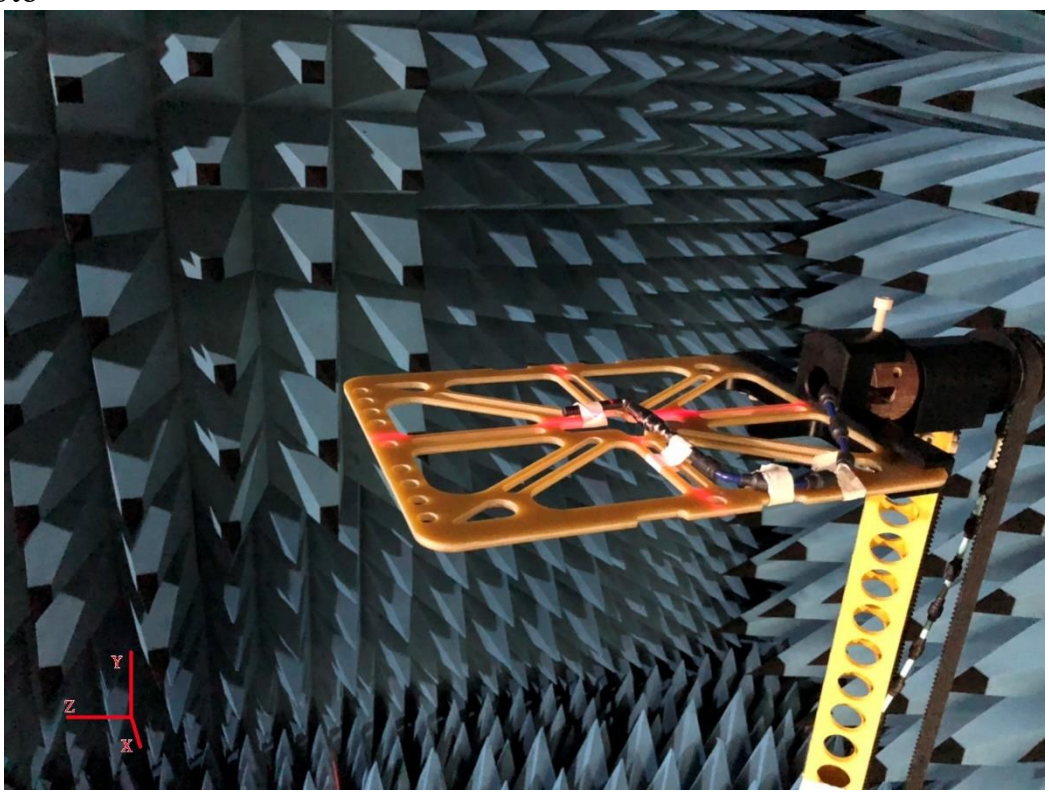

3D Test Data

Choose	Freq. / Chan.	Color
<input checked="" type="checkbox"/>	824MHz	Red
<input checked="" type="checkbox"/>	960MHz	Blue
<input checked="" type="checkbox"/>	1.71GHz	Green
<input checked="" type="checkbox"/>	1.99GHz	Magenta

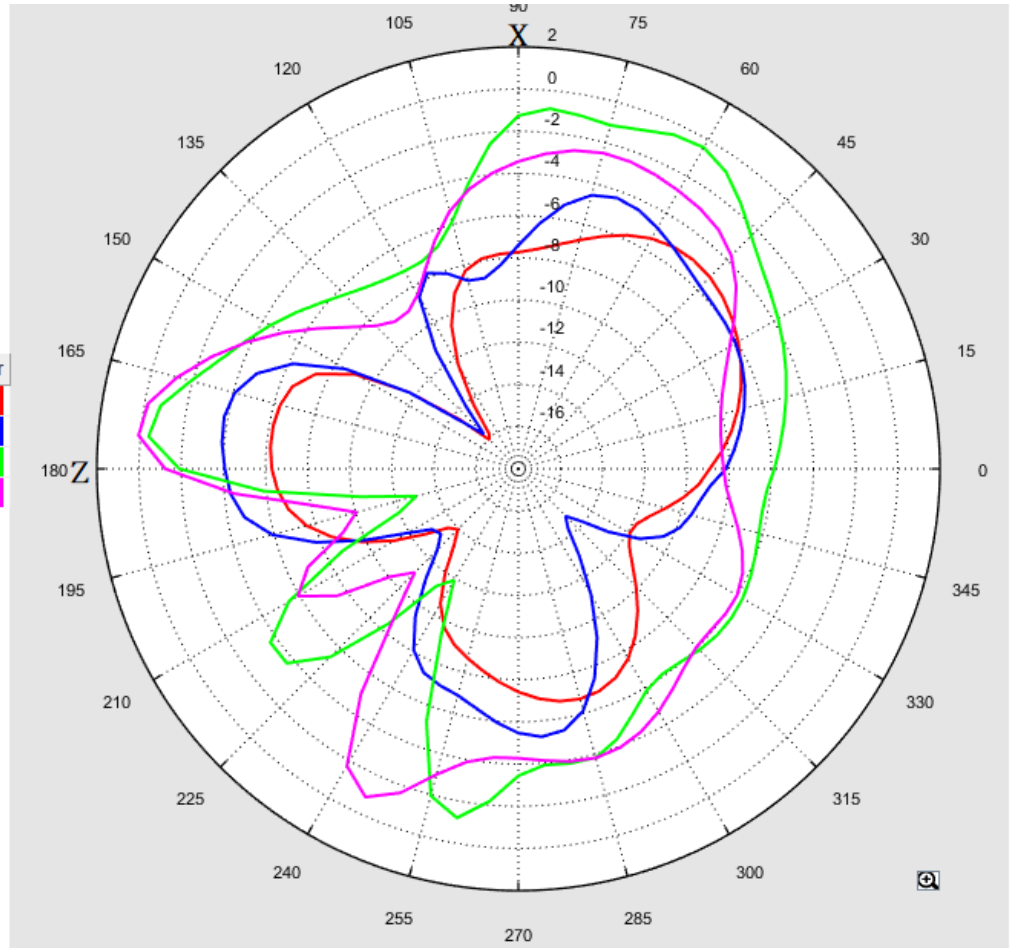

Total_Efficiency (%)

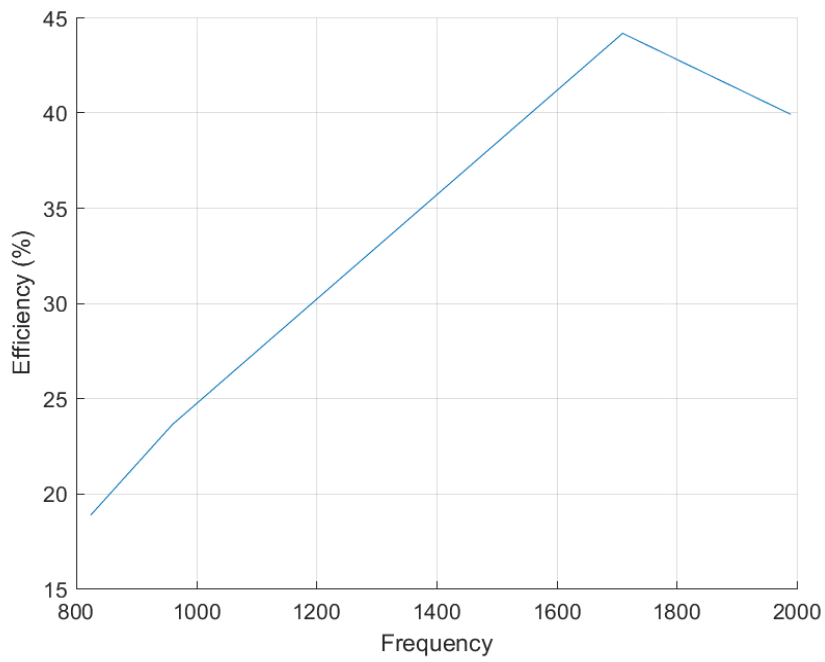

Total_Gain (dBi)

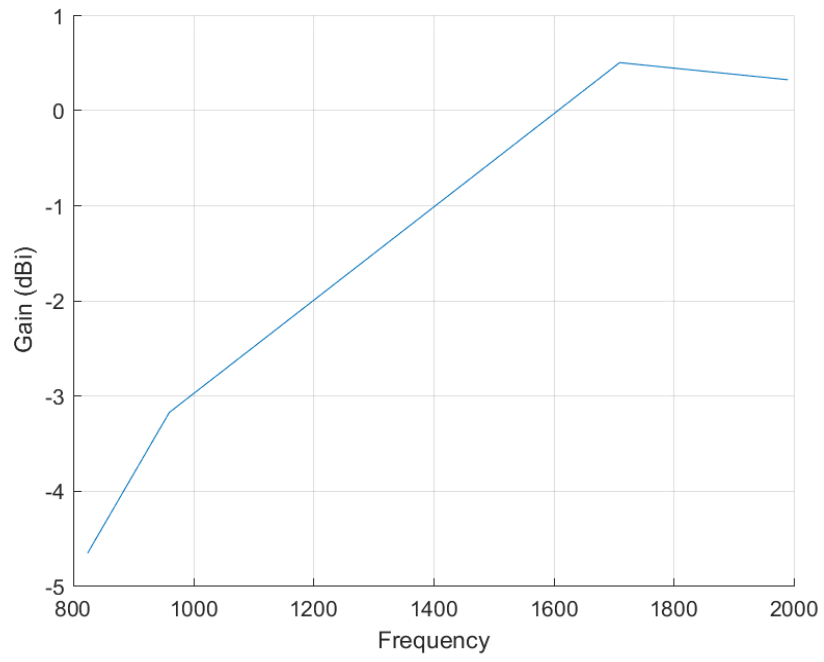

Total_3D_Top View_824MHz

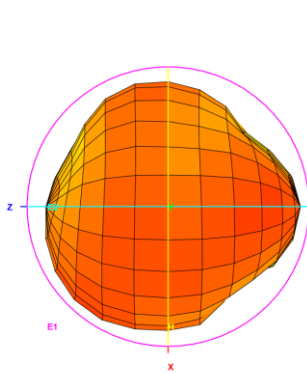

Total_3D_Front View_824MHz

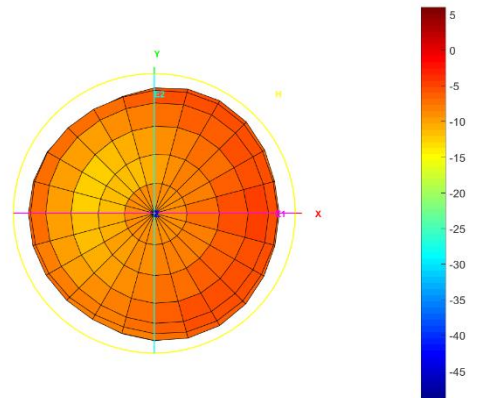

Total_3D_Left View_824MHz

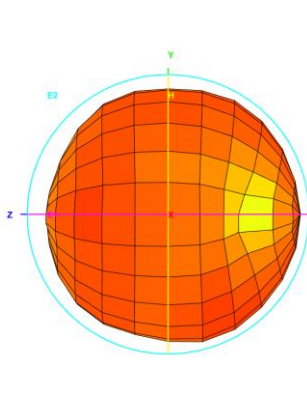

Total_3D_Side View 1_824MHz

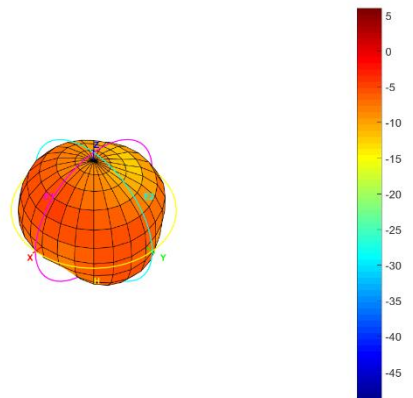

Total_3D_Top View_960MHz

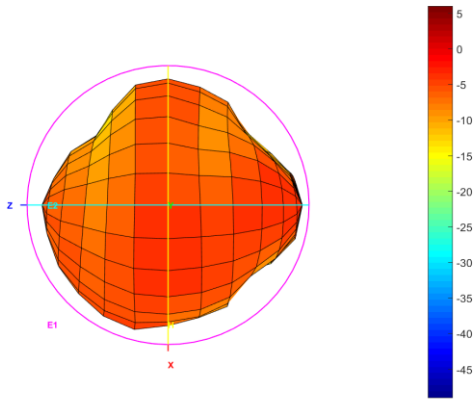

Total_3D_Front View_960MHz

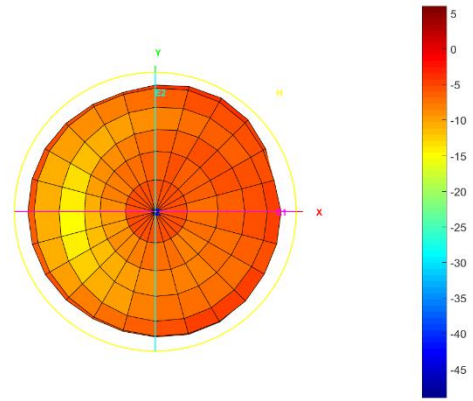

Total_3D_Left View_960MHz

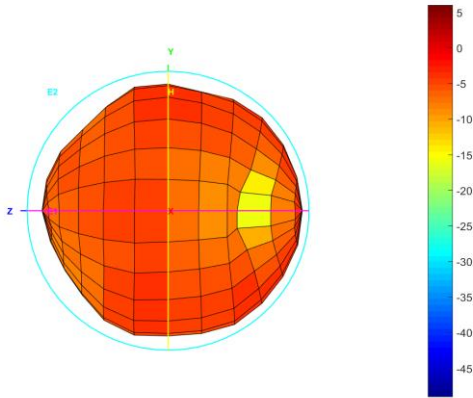

Total_3D_Side View 1_960MHz

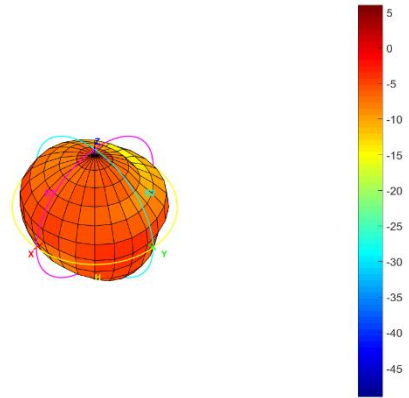

Total_3D_Top View_1.71GHz

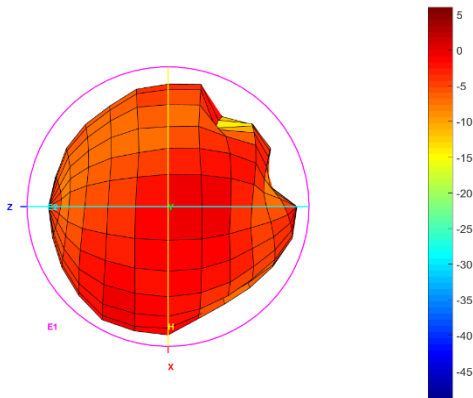

Total_3D_Front View_1.71GHz

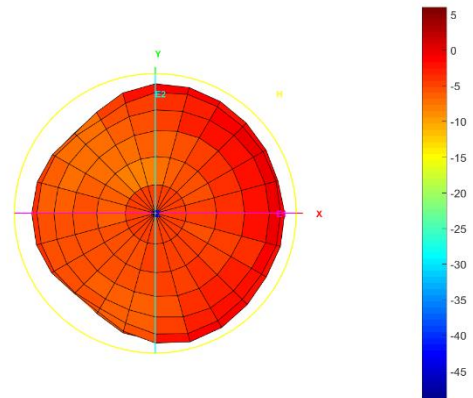

Total_3D_Left View_1.71GHz

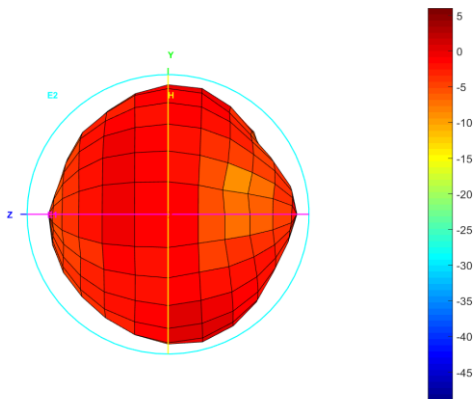

Total_3D_Side View 1_1.71GHz

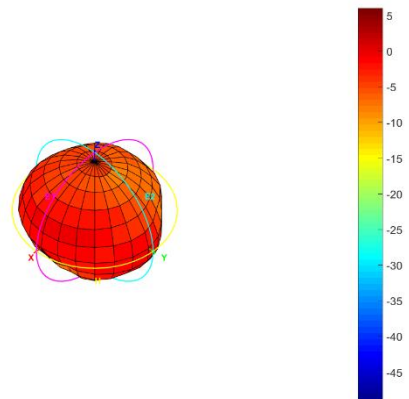

Total_3D_Top View_1.99GHz

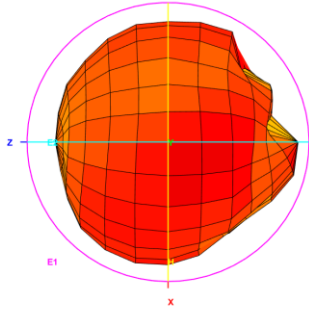

Total_3D_Front View_1.99GHz

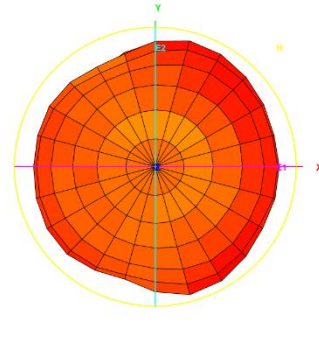

Total_3D_Left View_1.99GHz

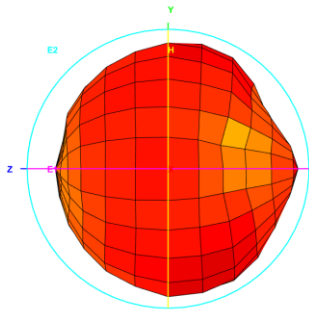

Total_3D_Side View 1_1.99GHz

